

Z 7

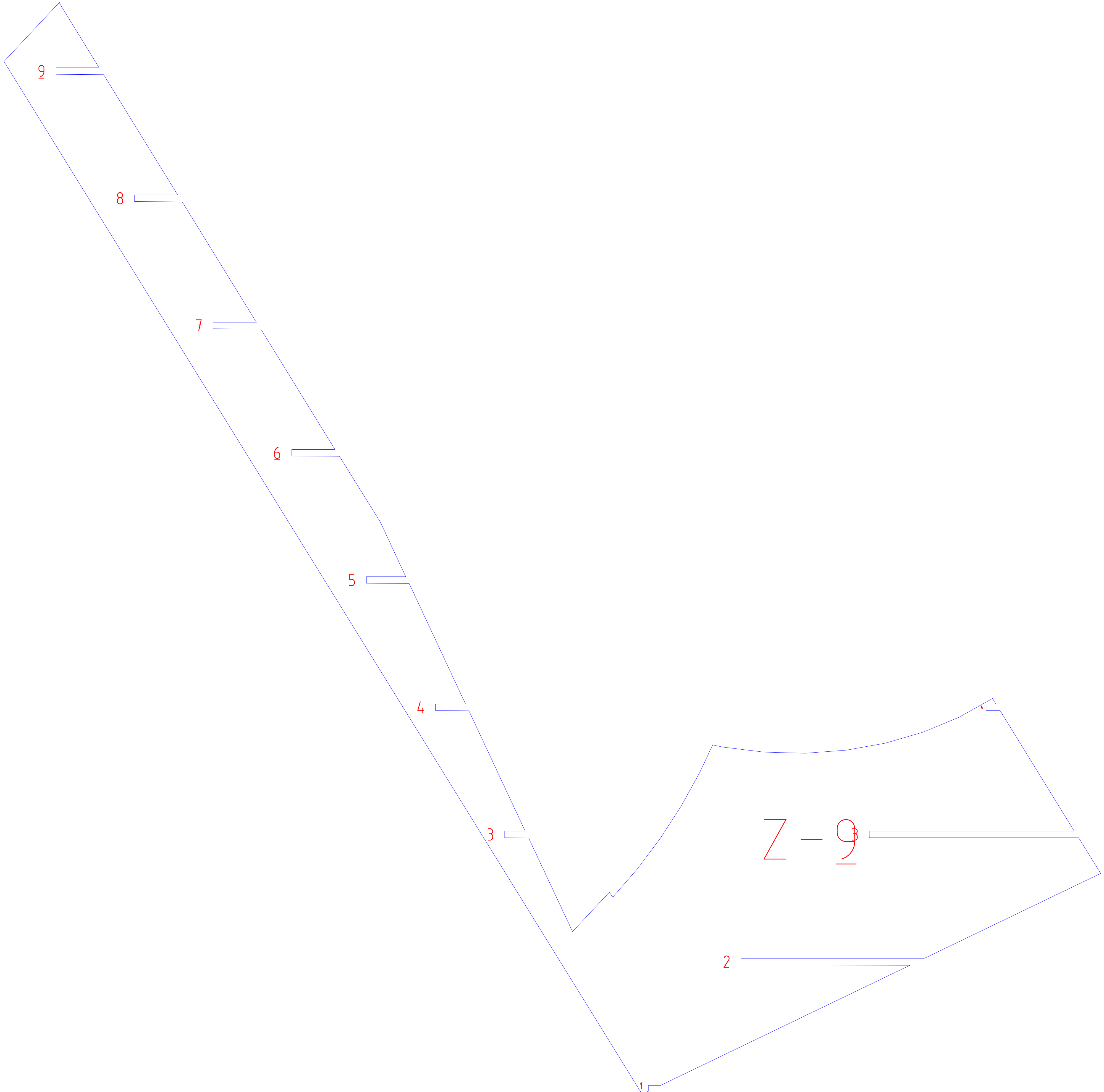

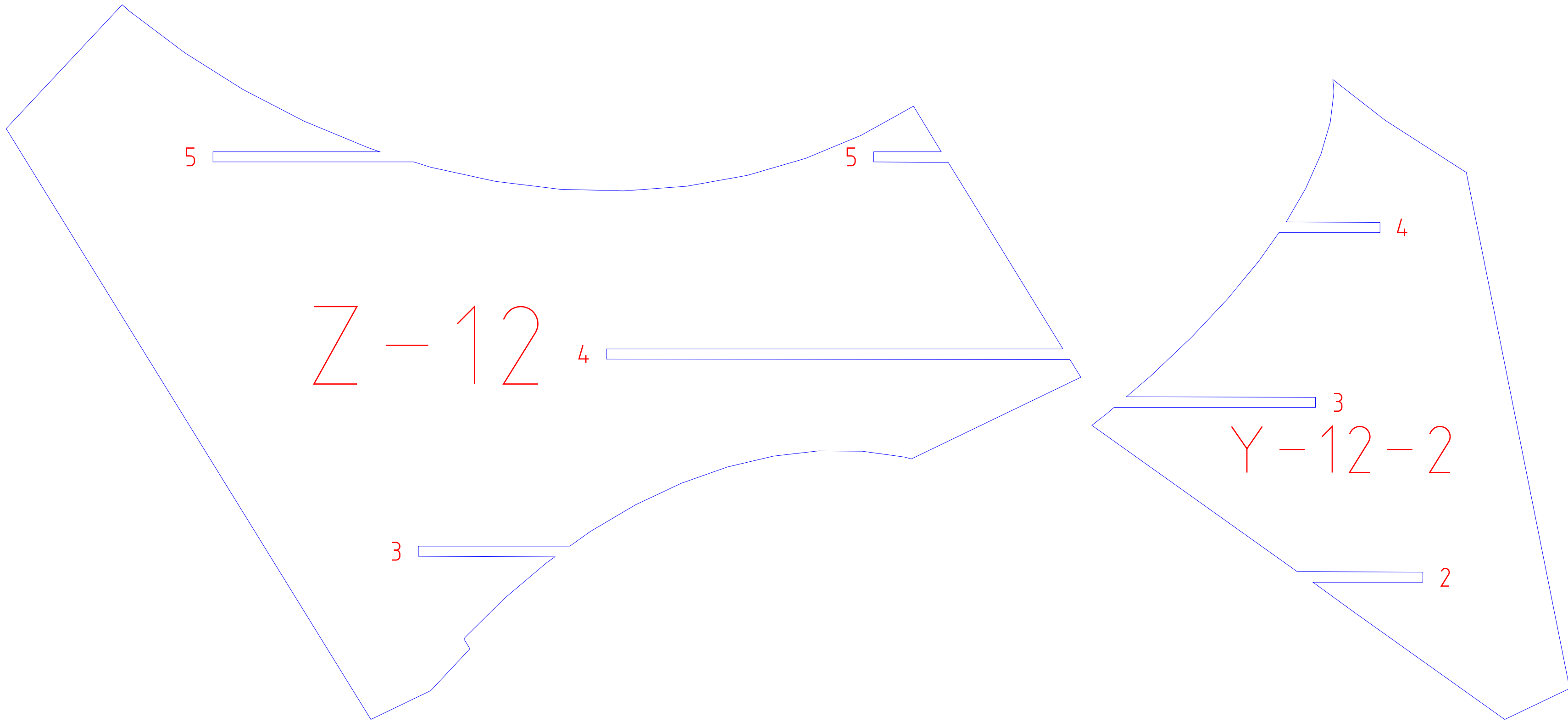

Z-6

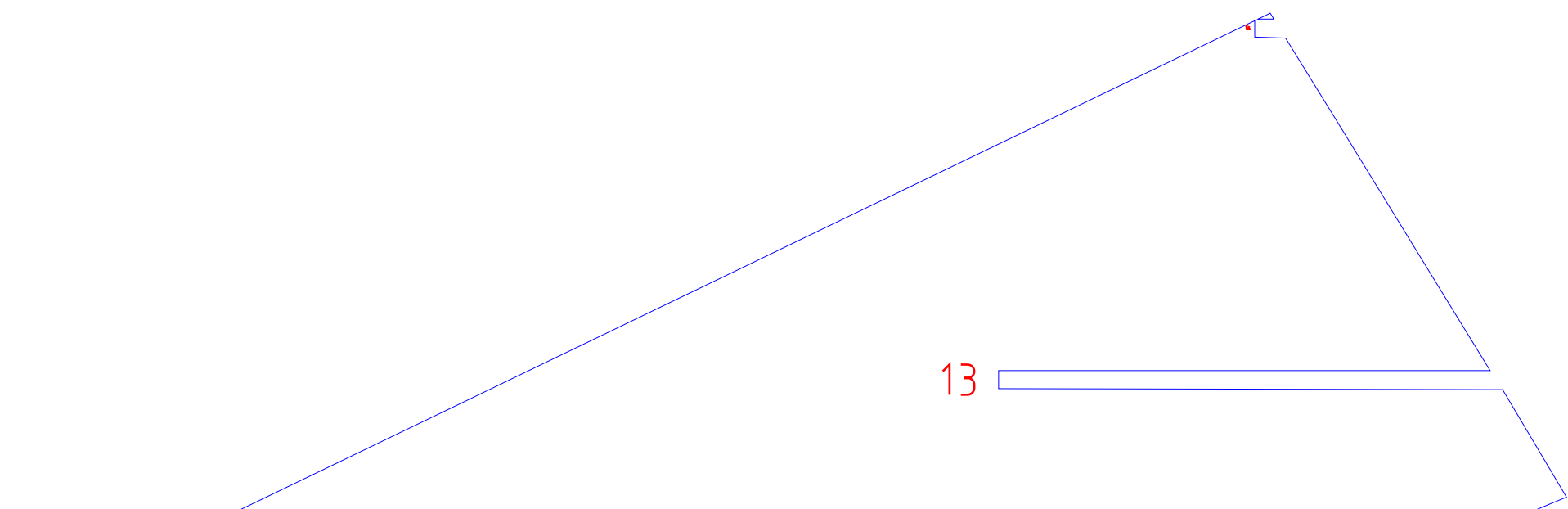
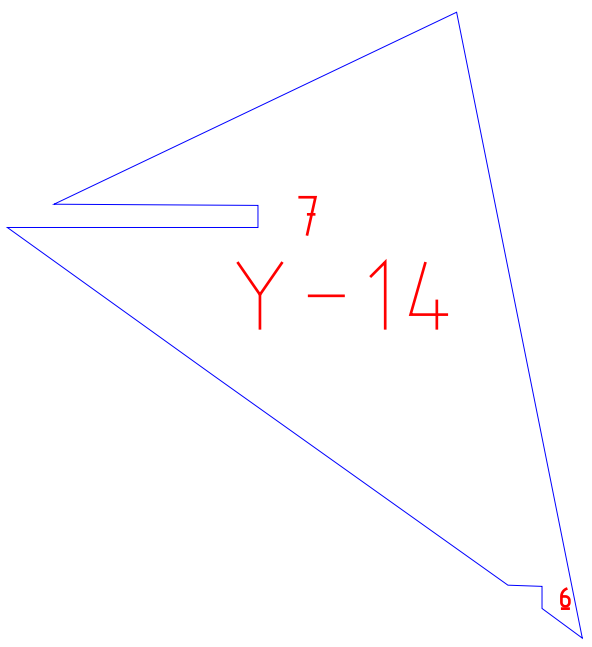
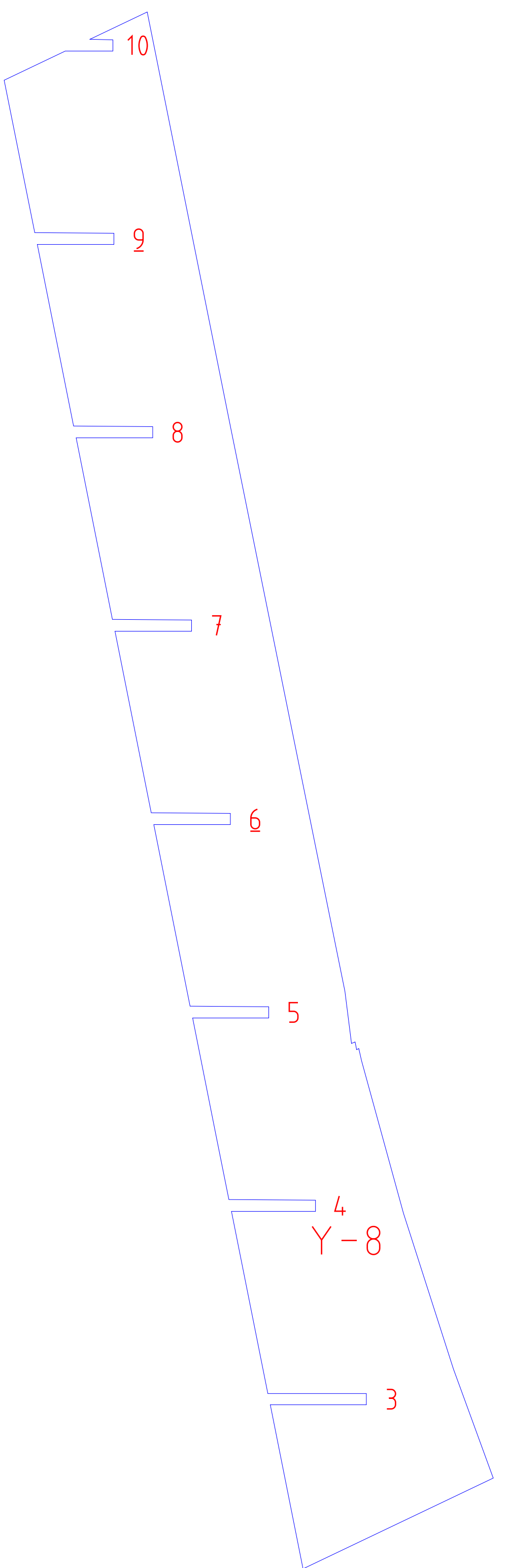
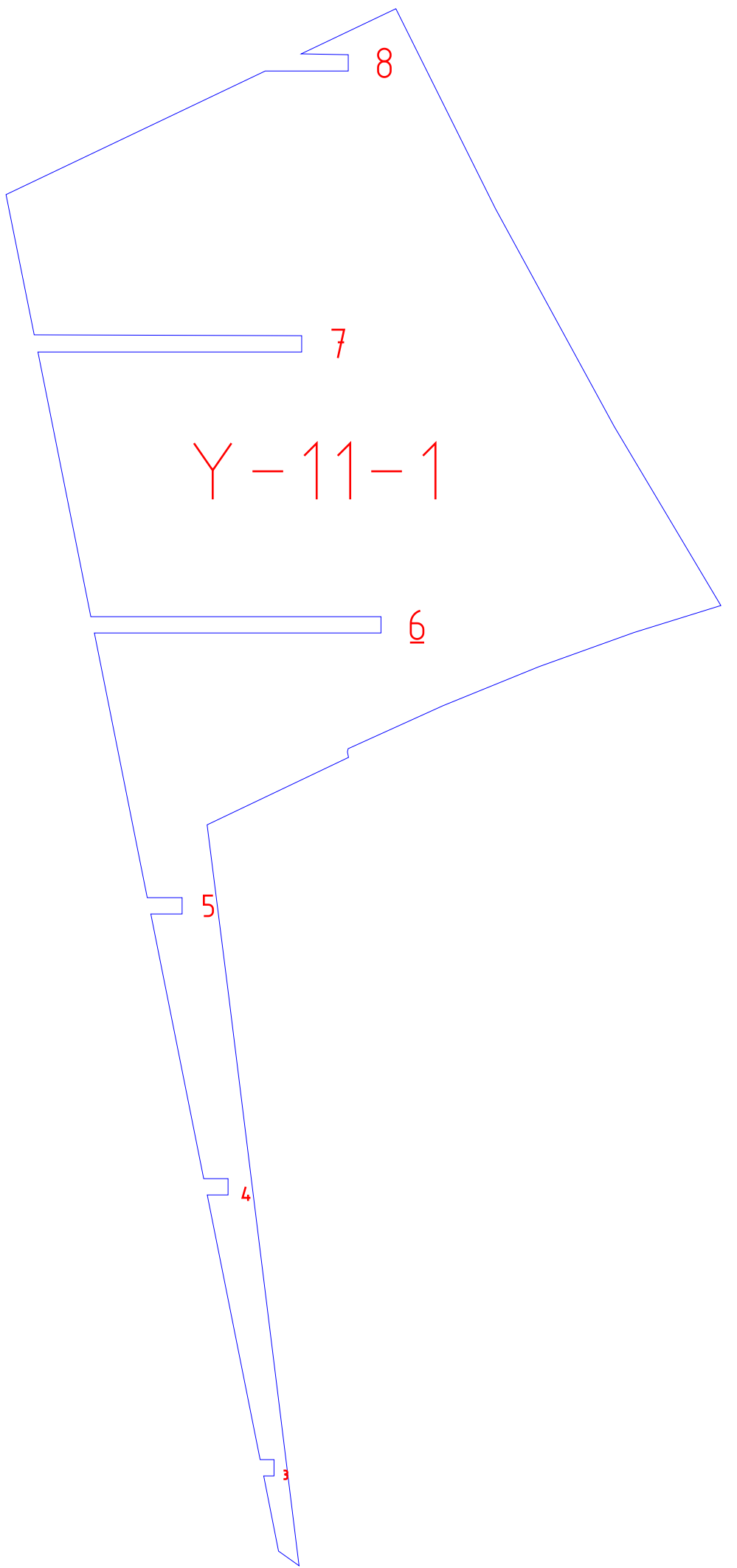
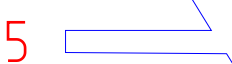
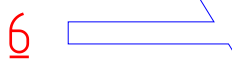
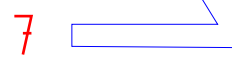
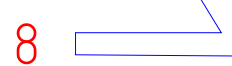
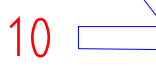
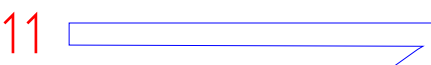

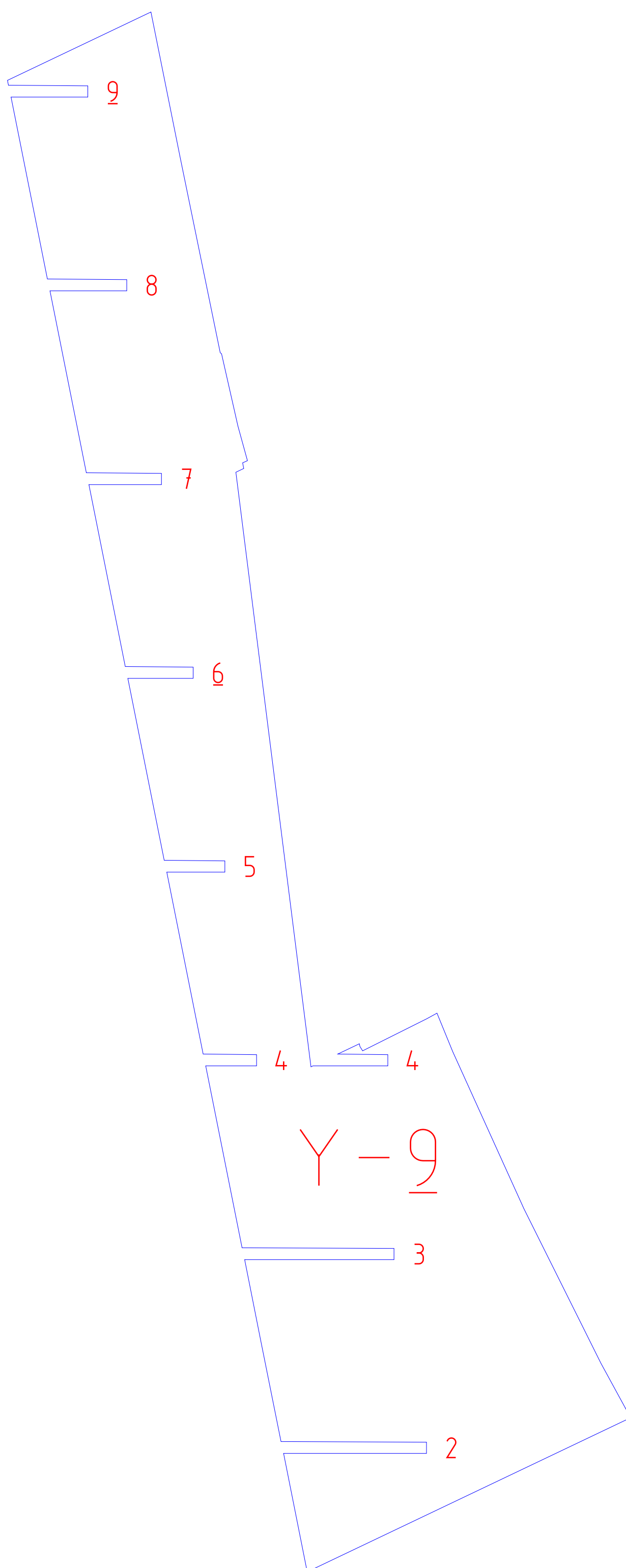
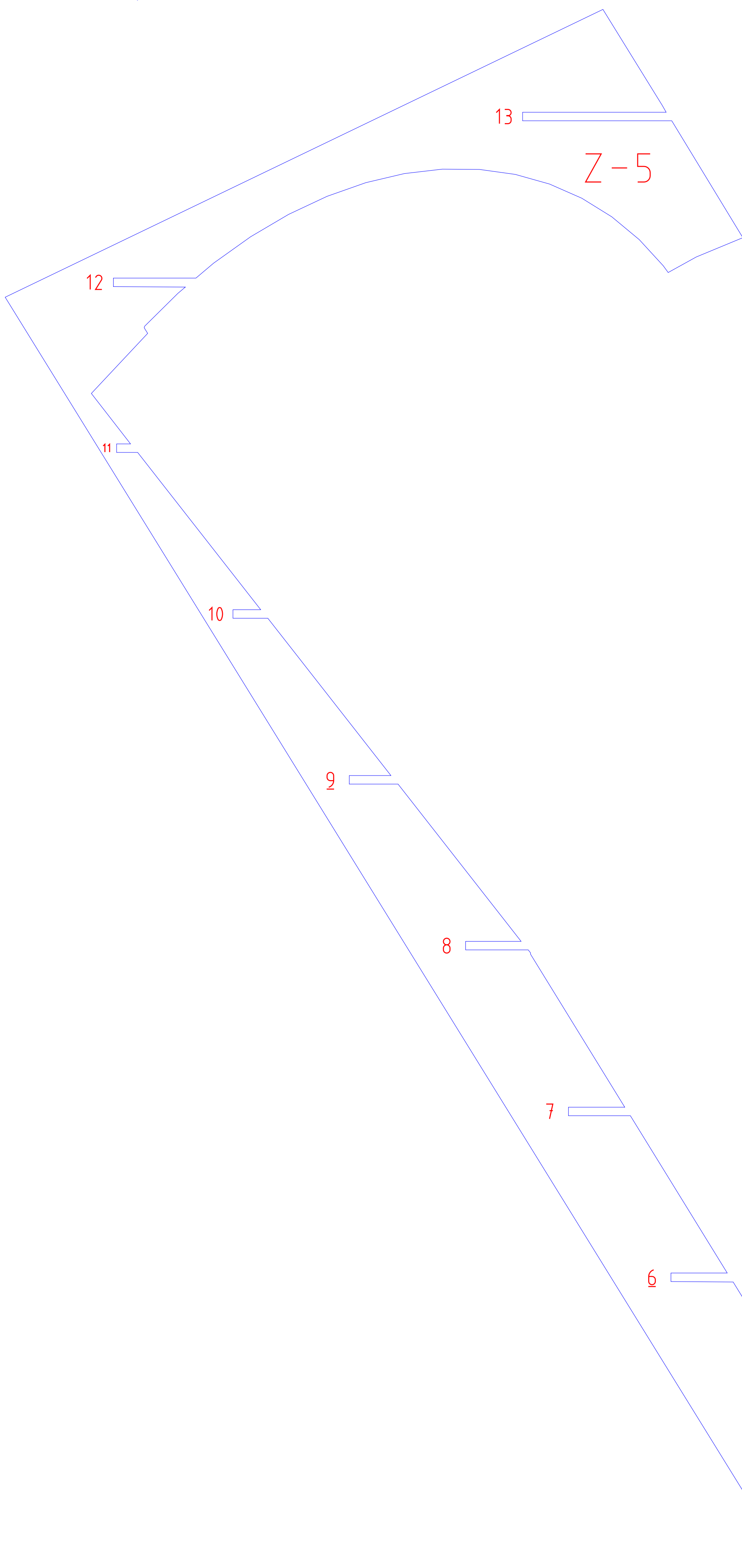
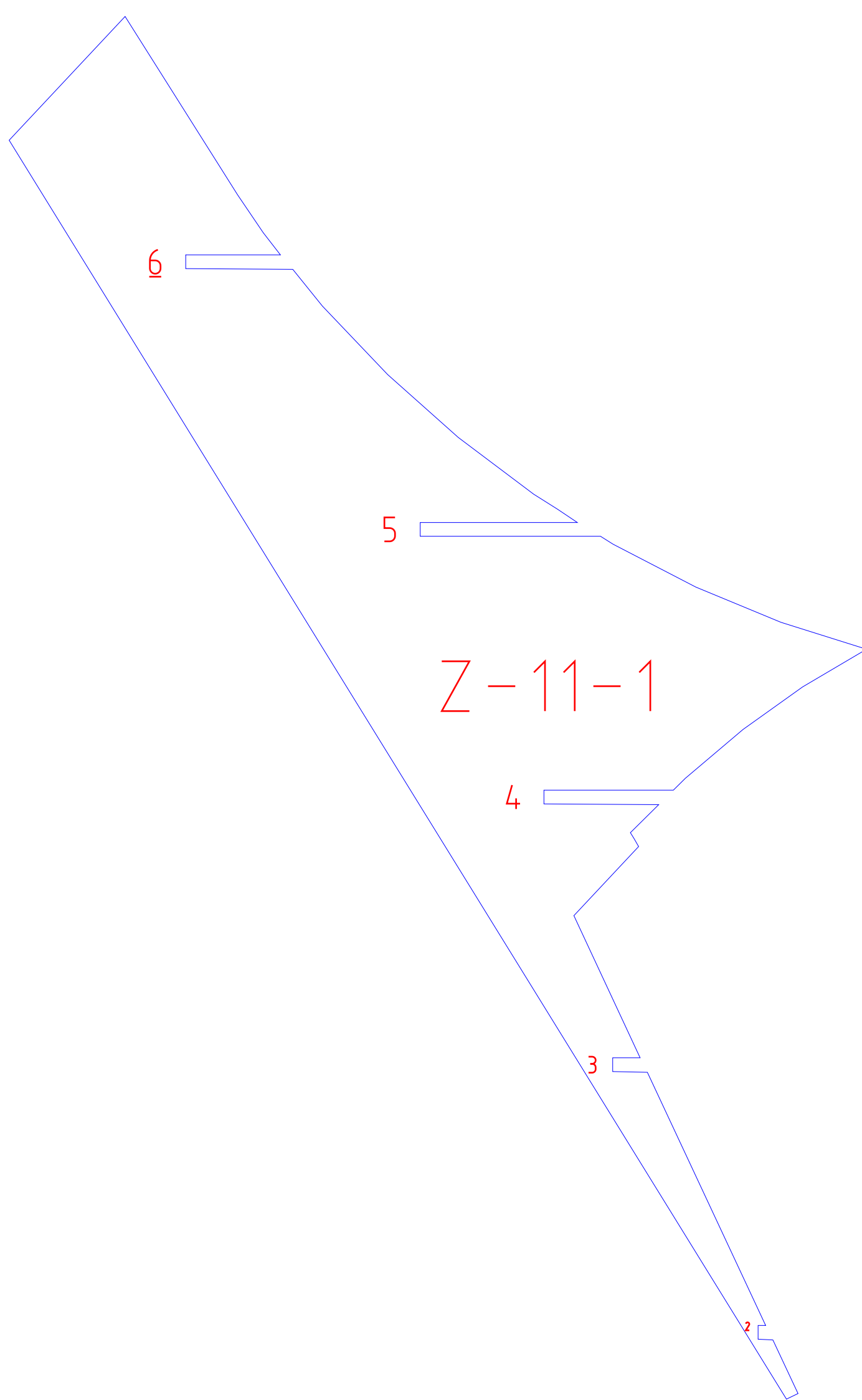
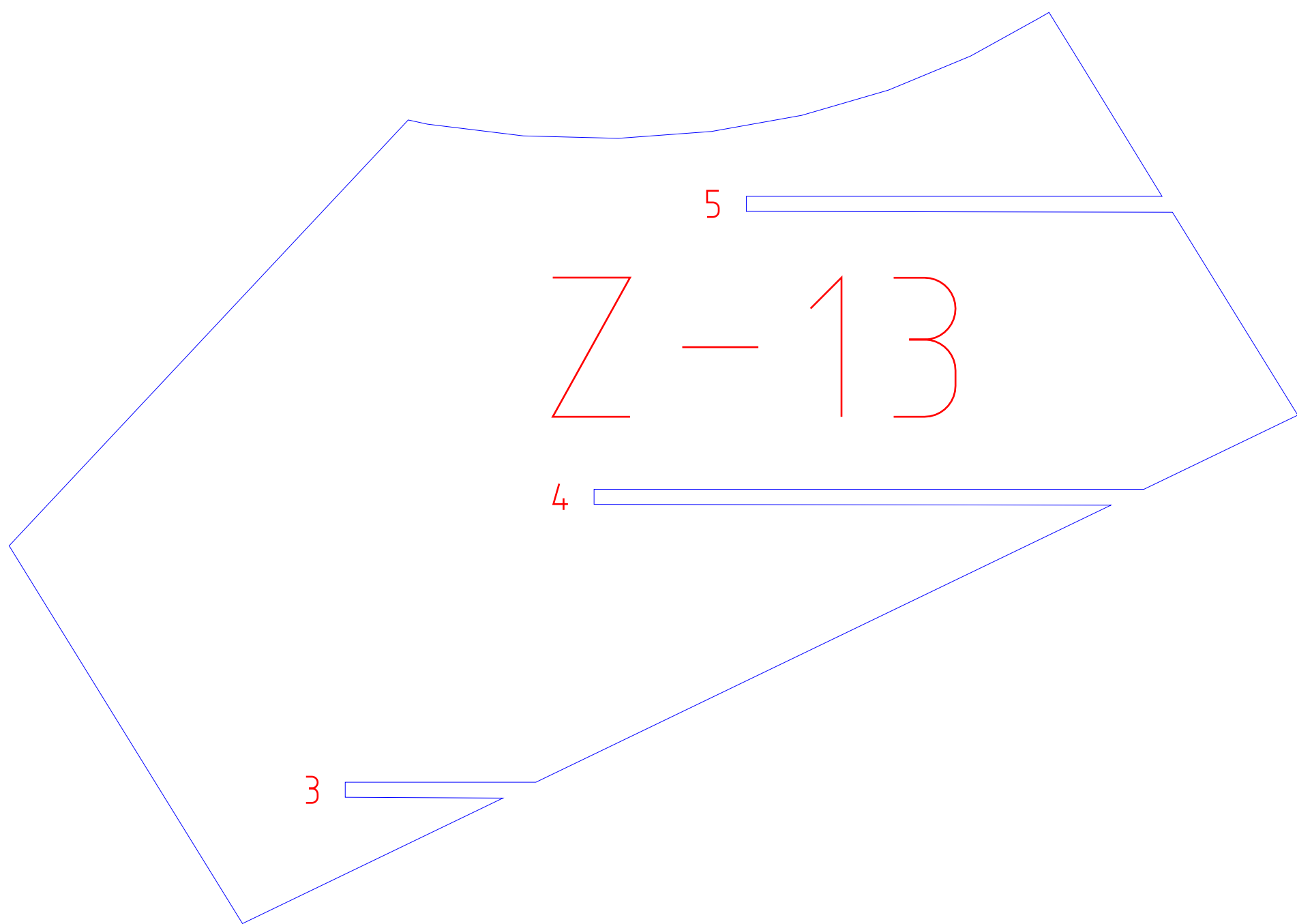

Z-2

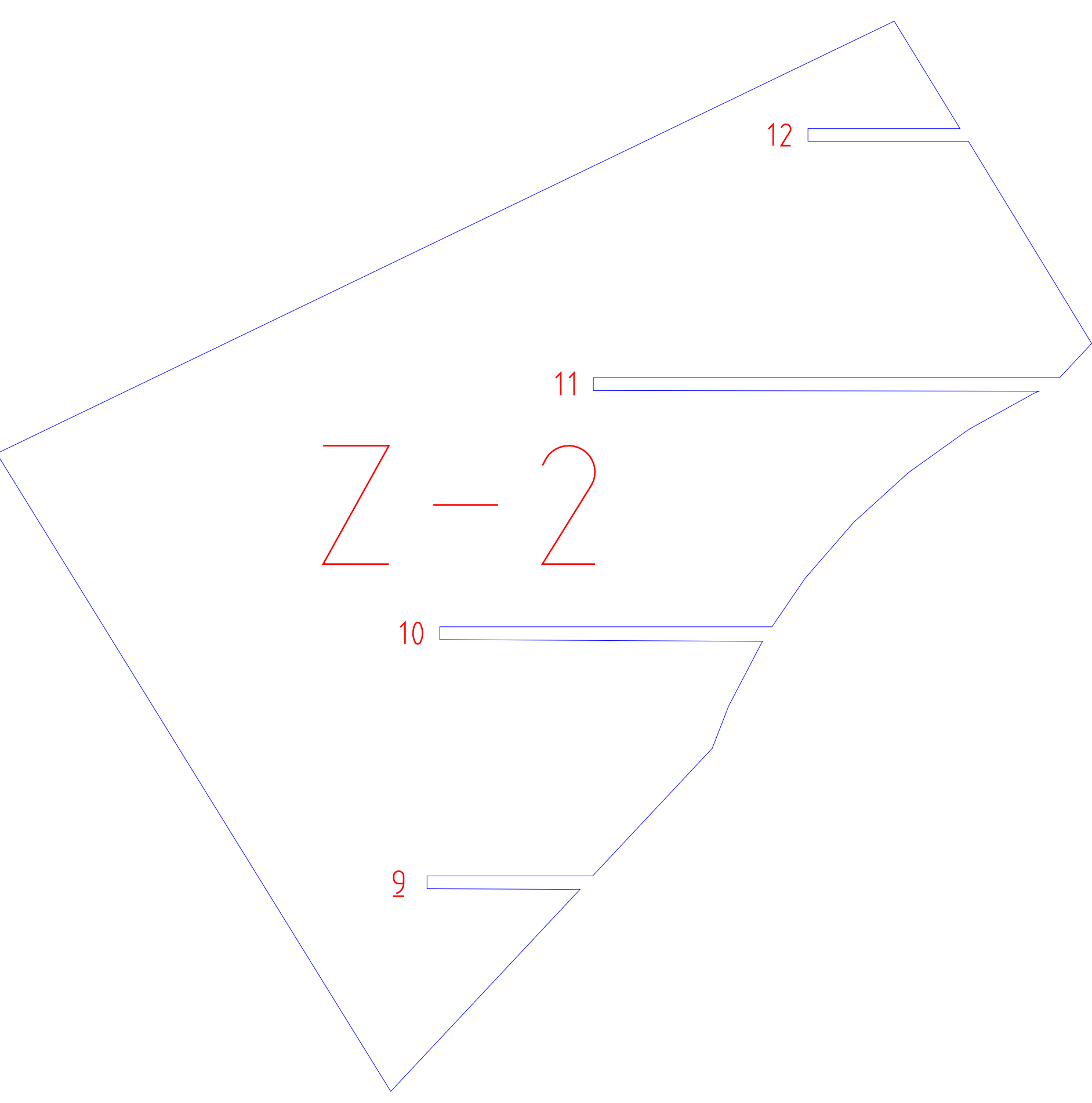

Y-2

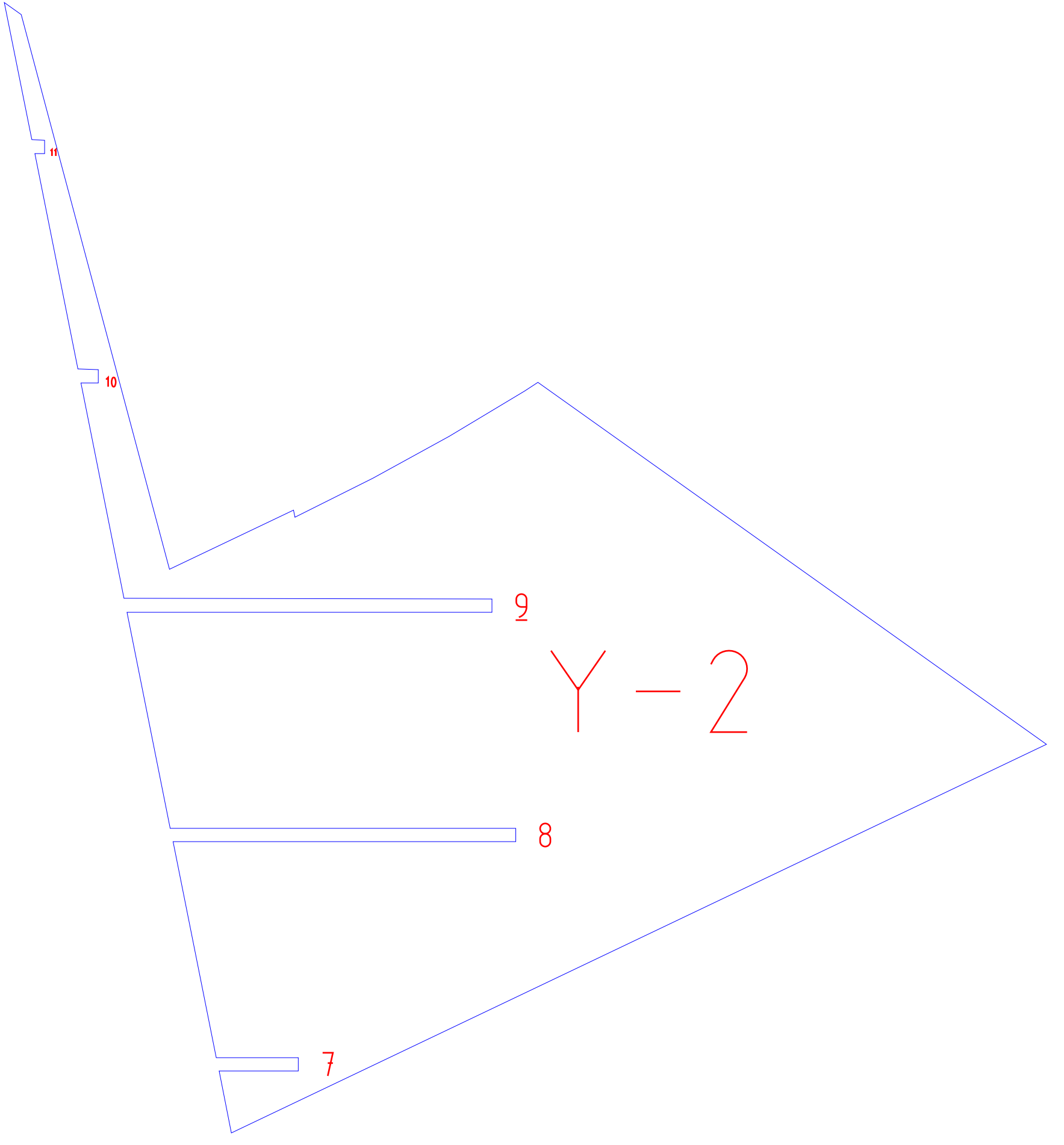

Y-4

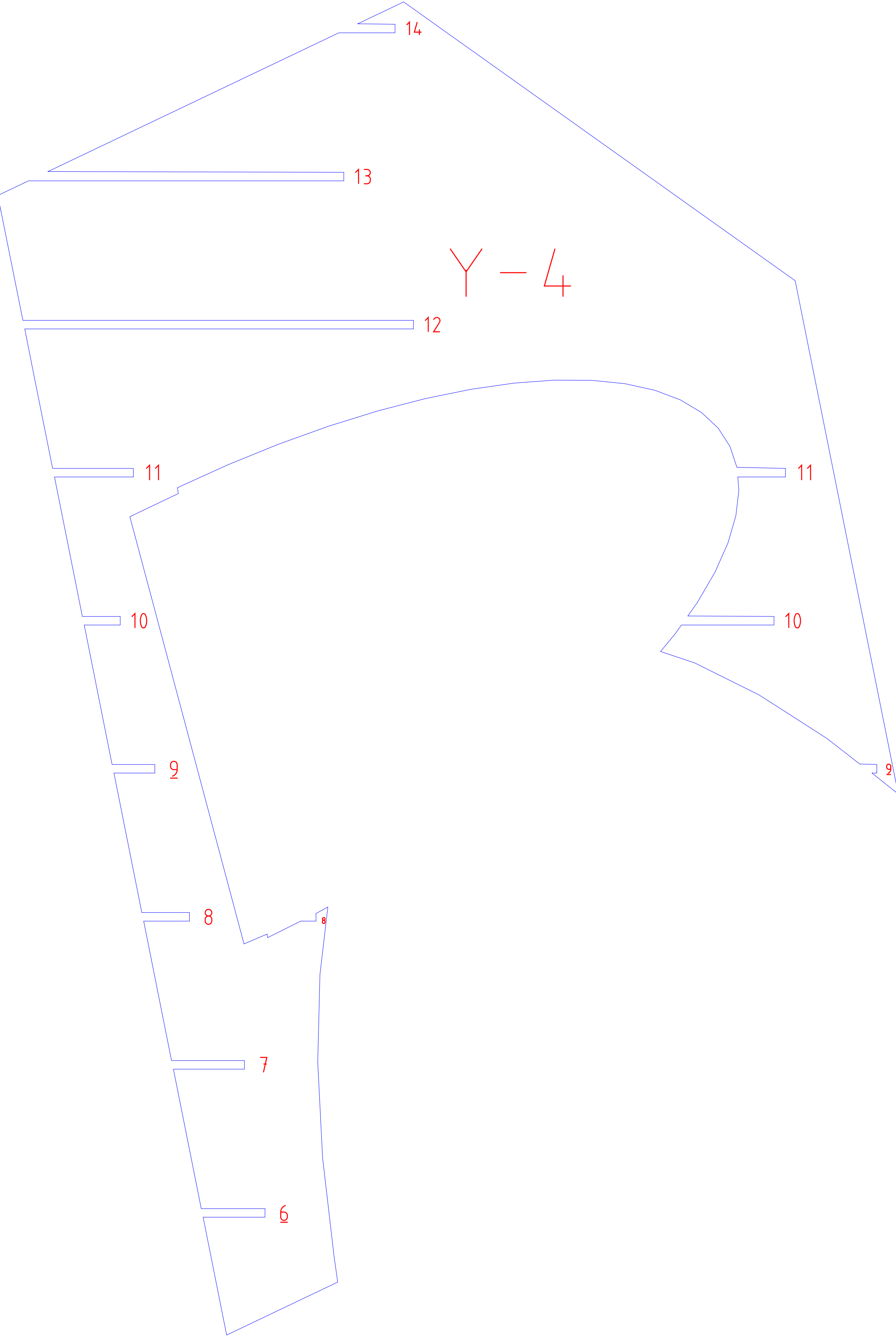

Y-6

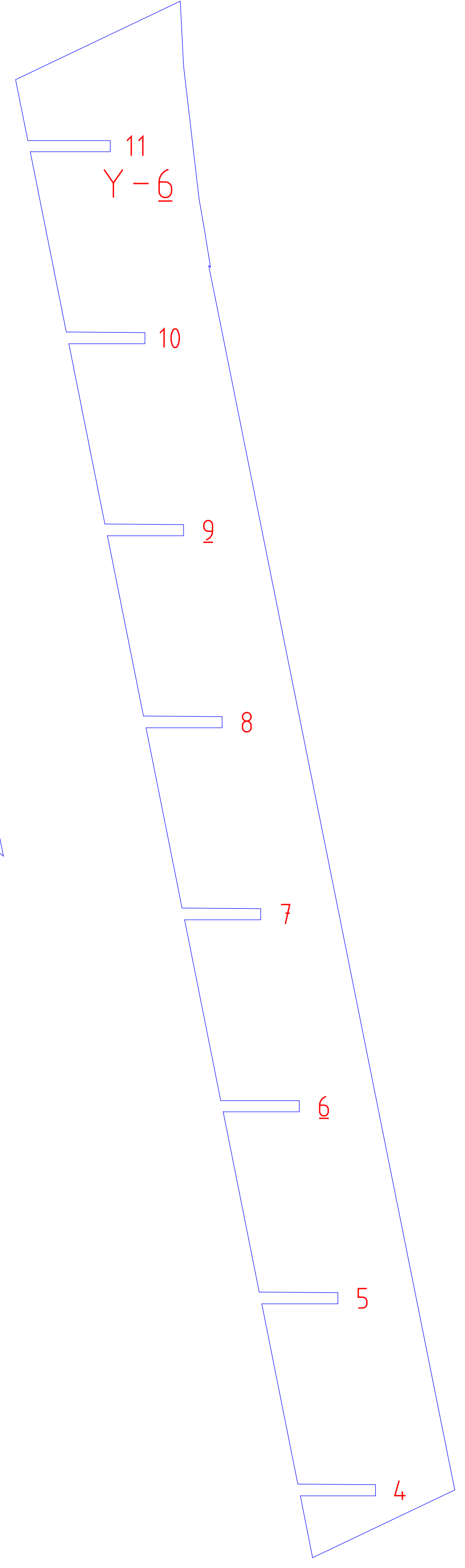

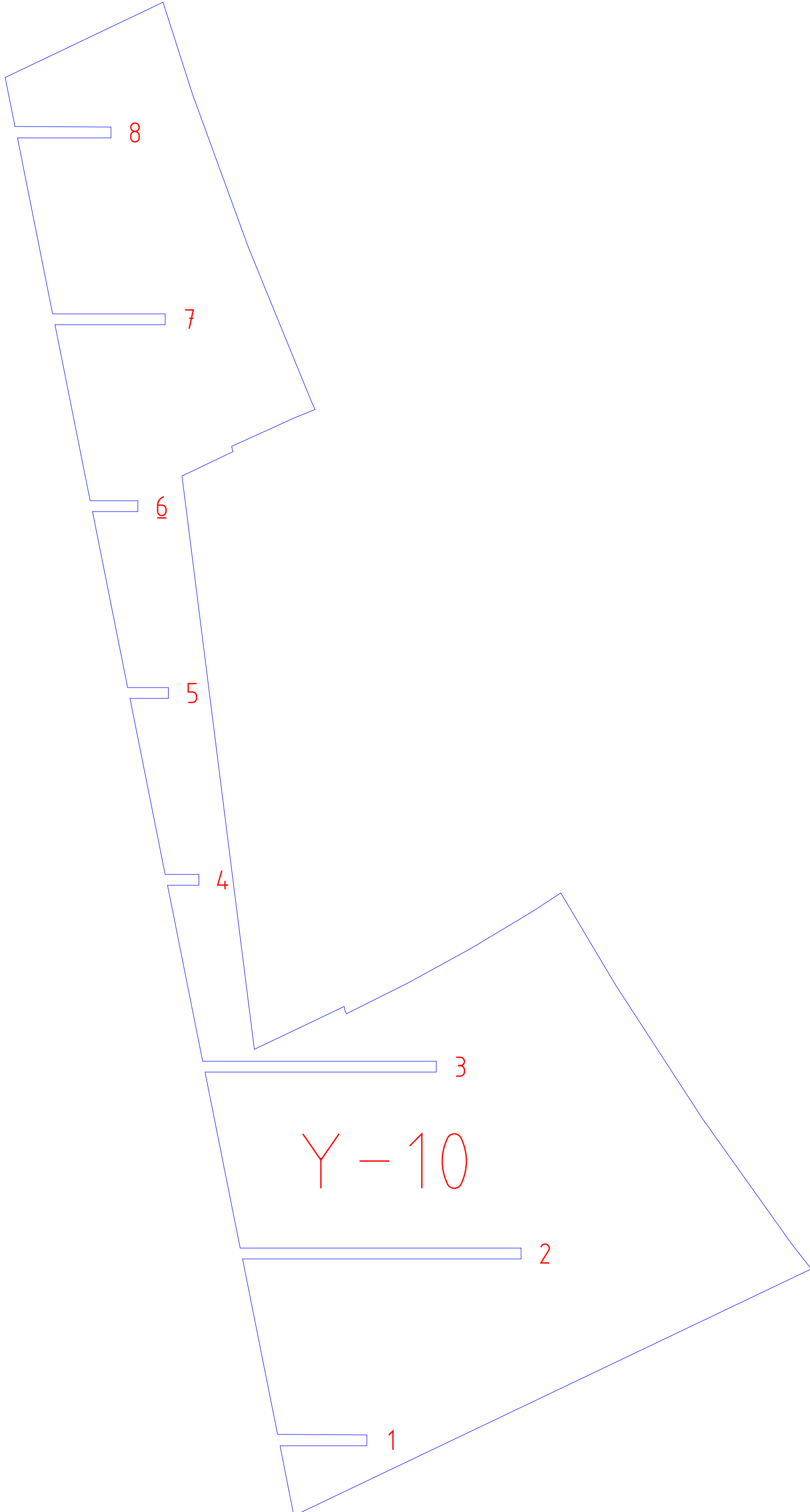
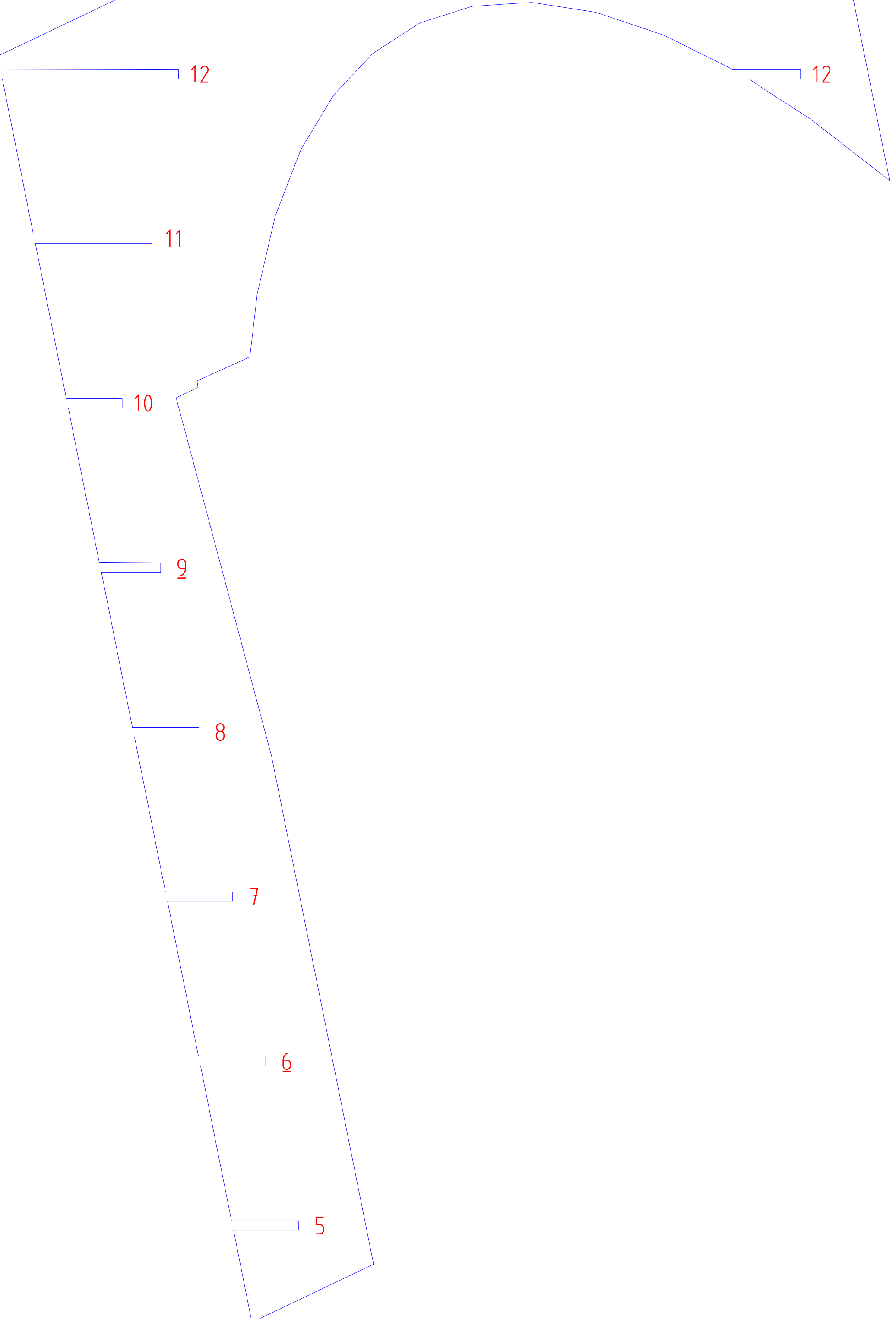
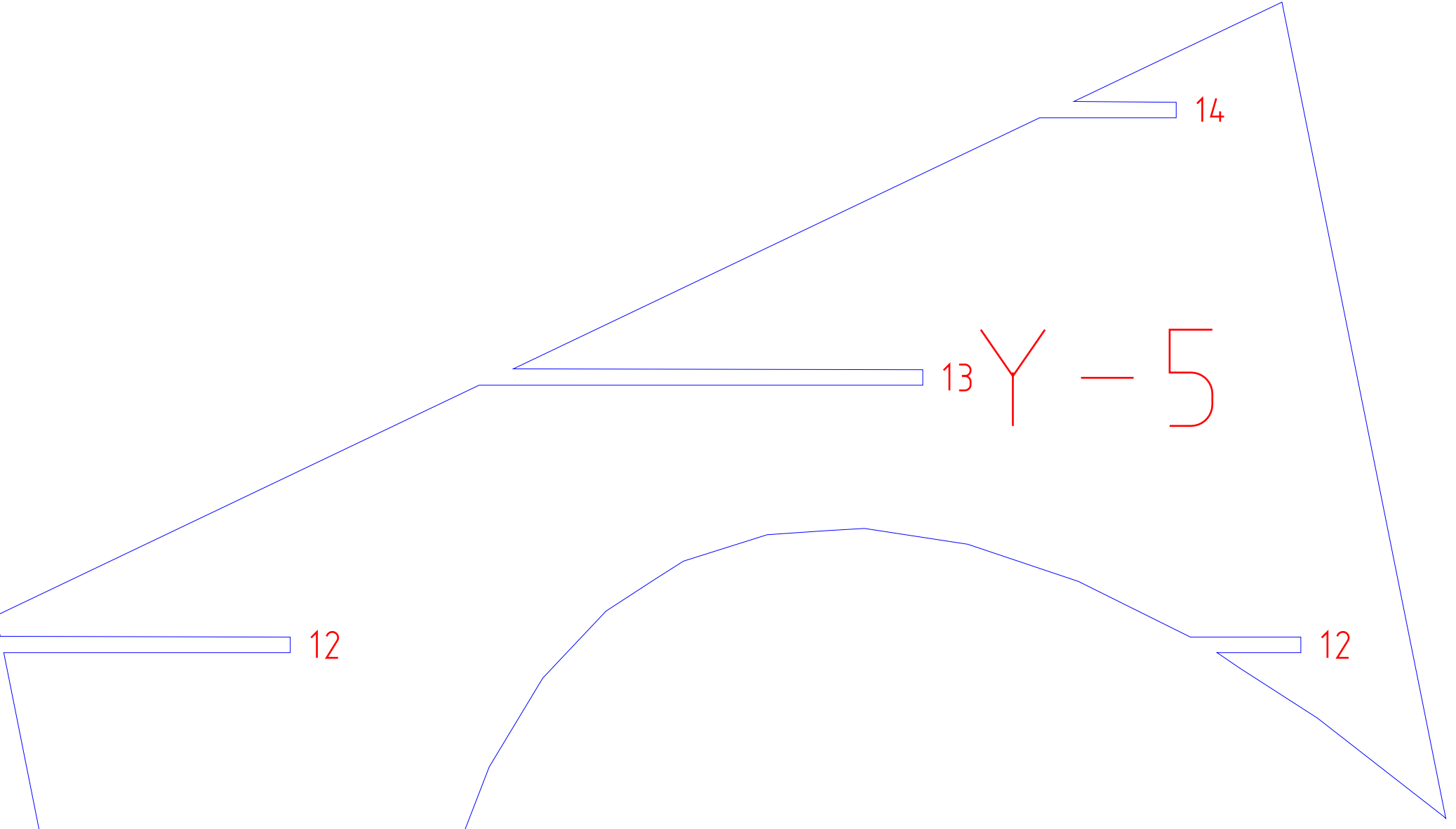
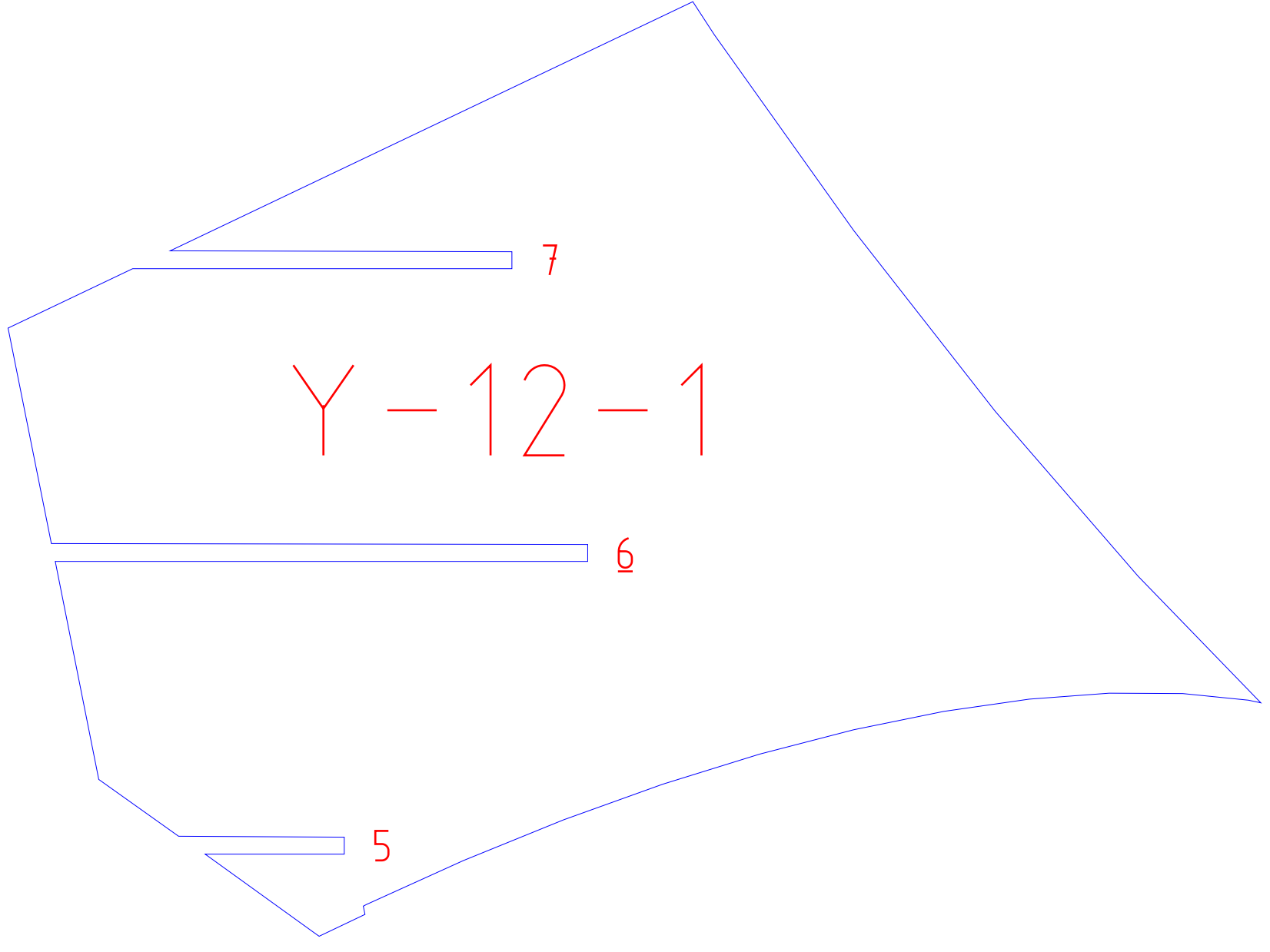
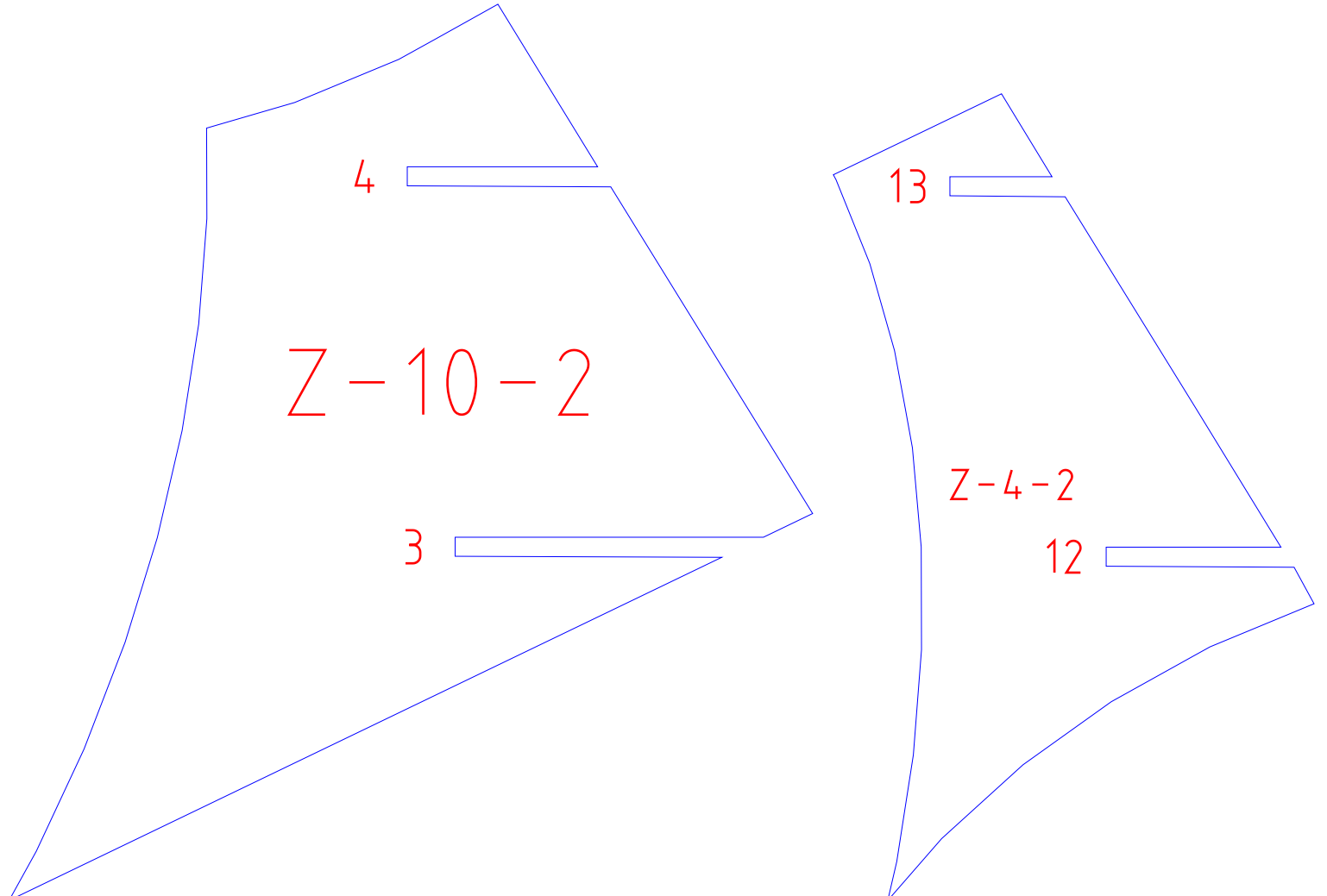
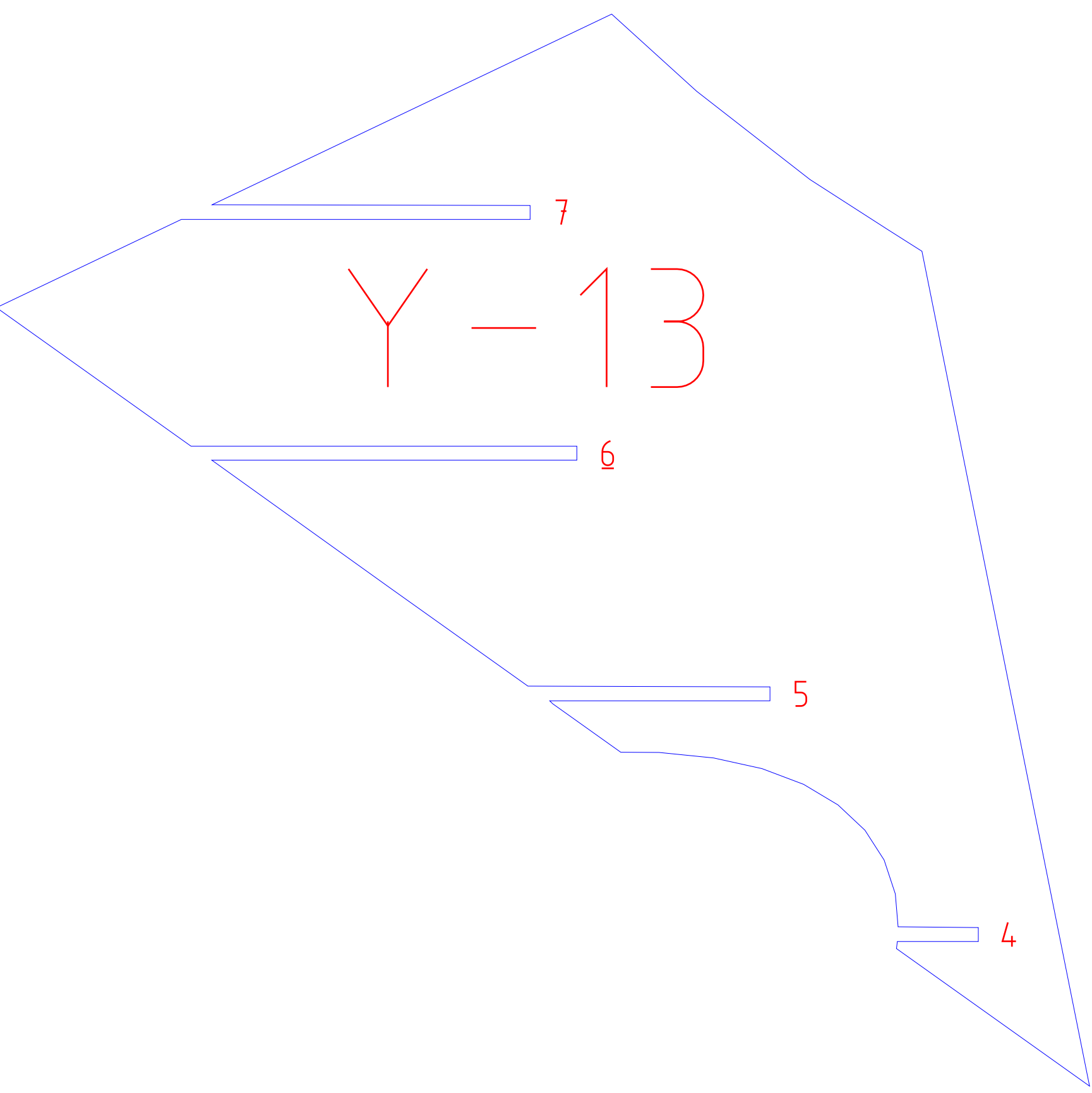

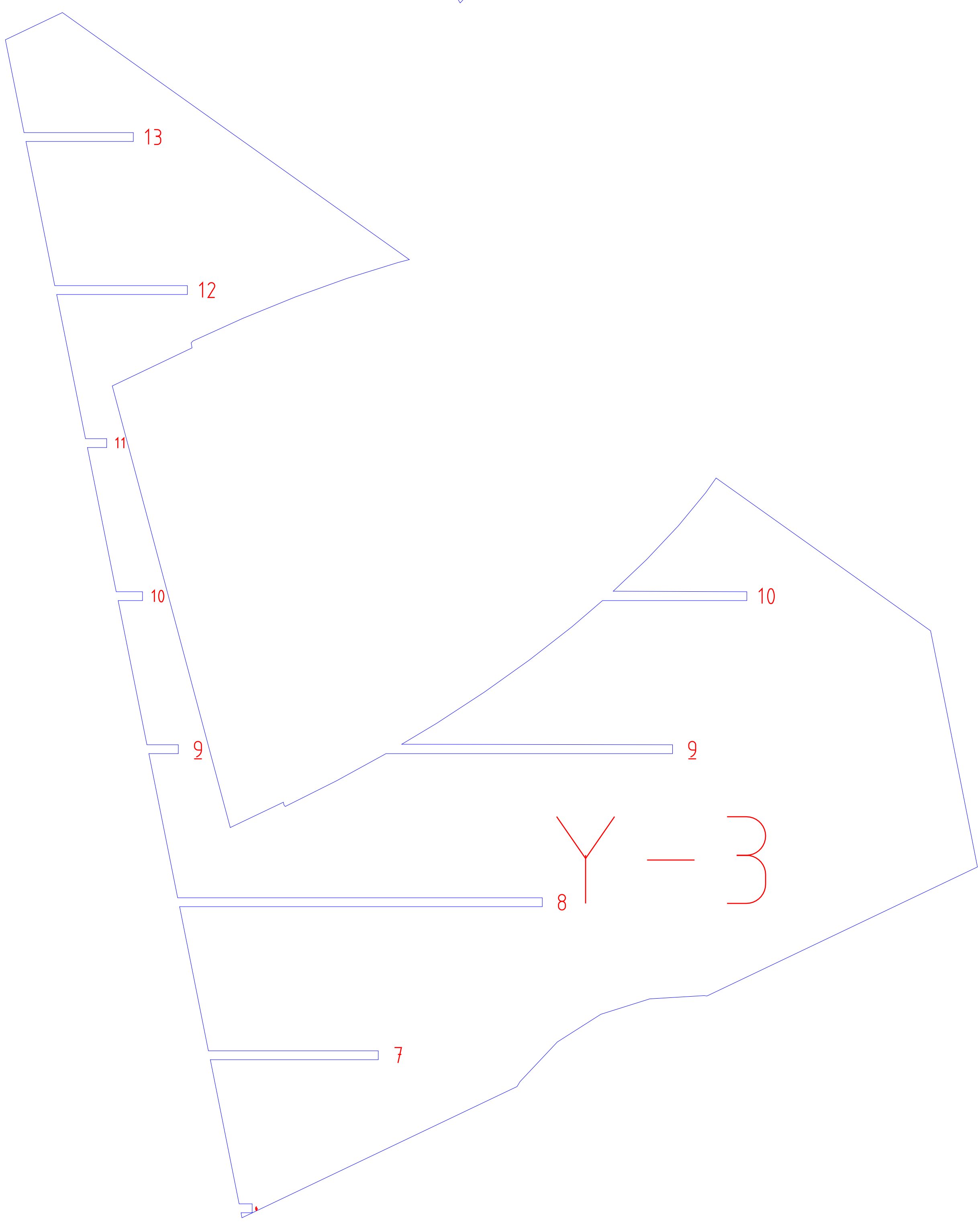
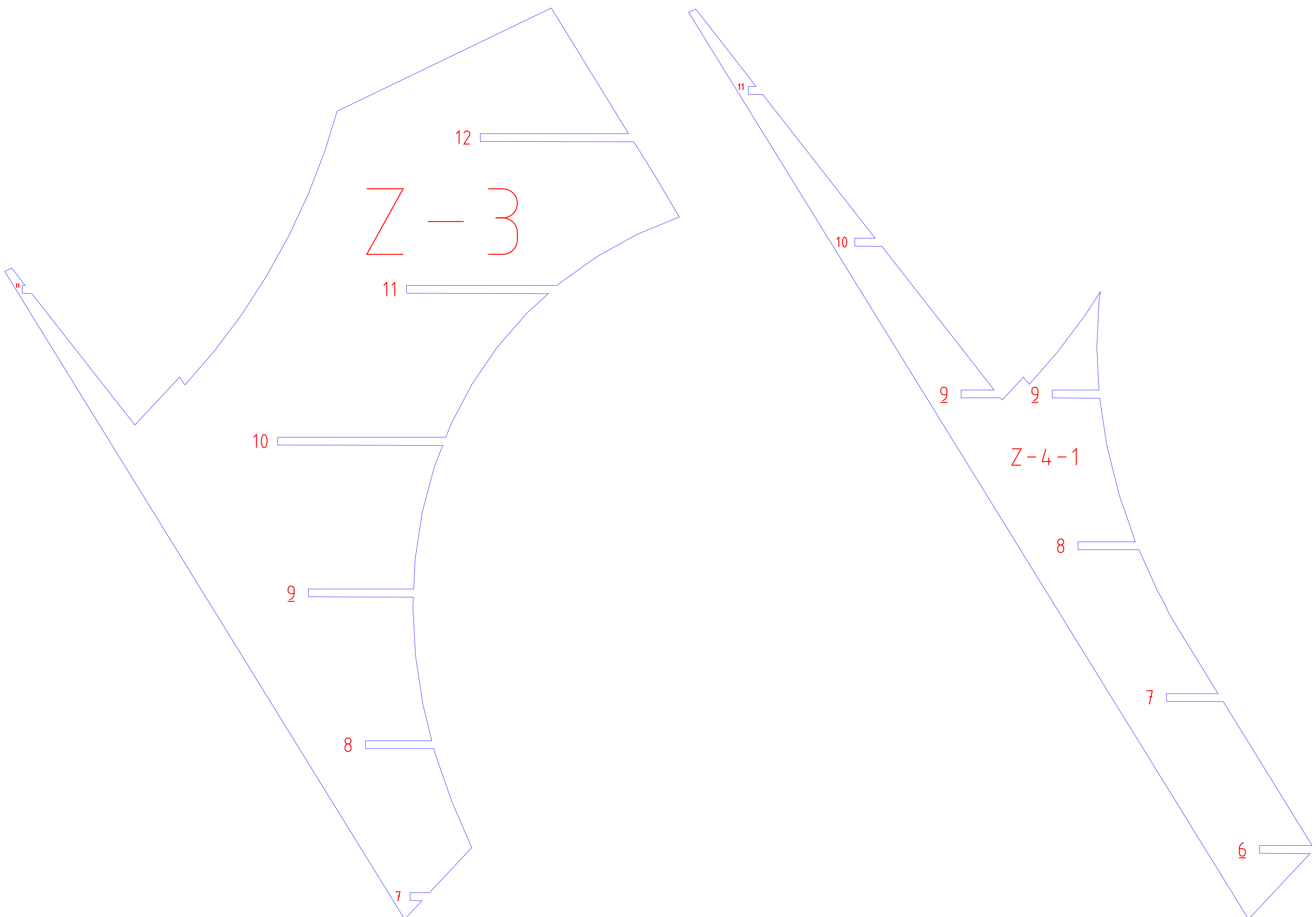



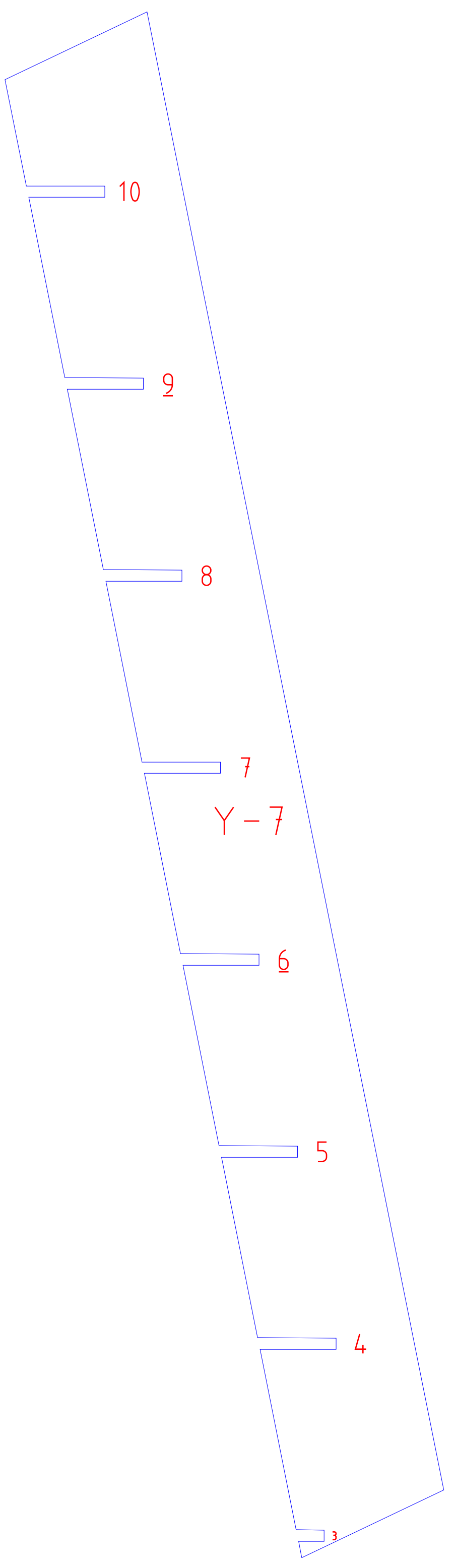
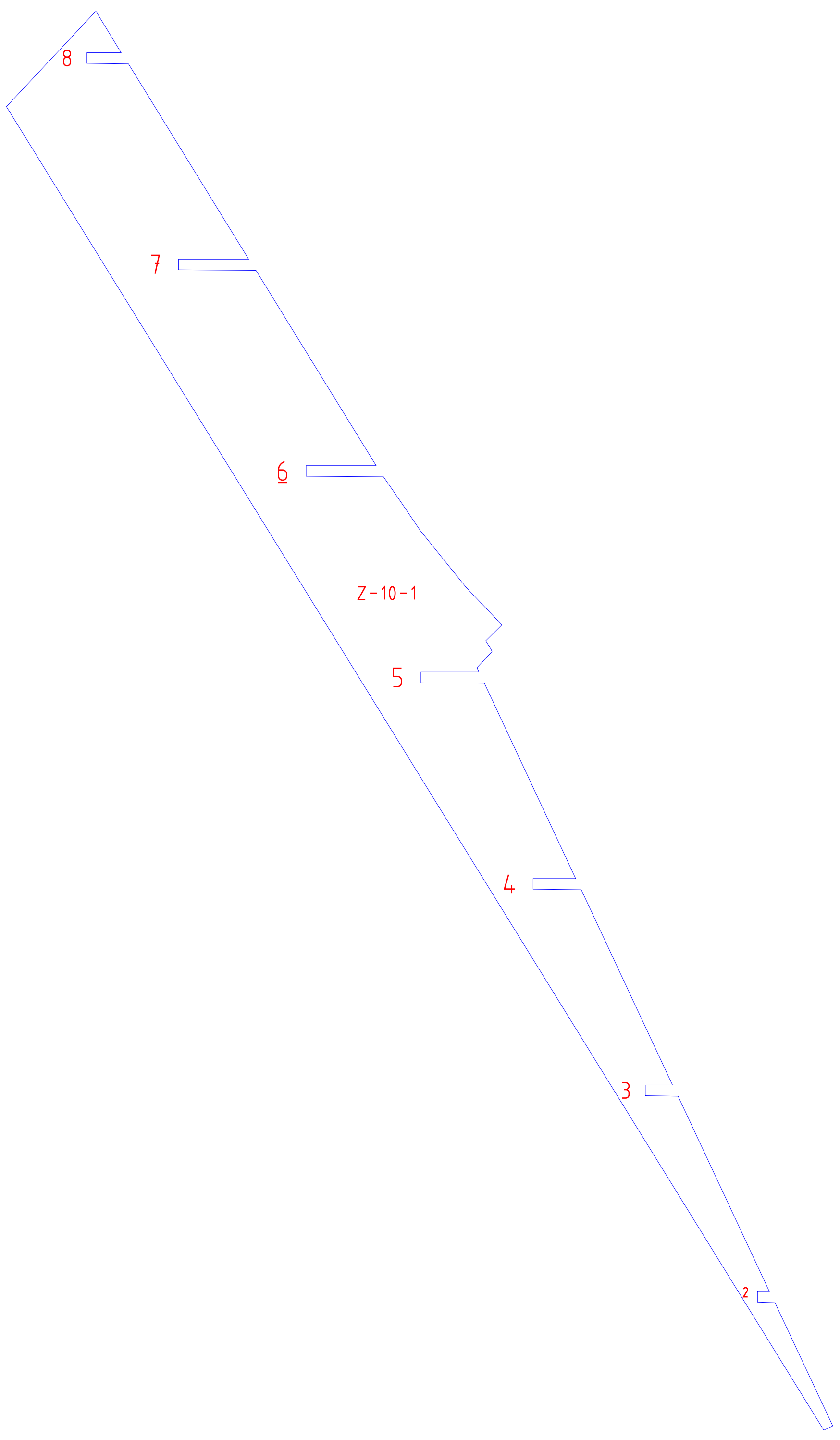

Y-11-2

3

2

1